

Rotatable Multi-Pocket Sources

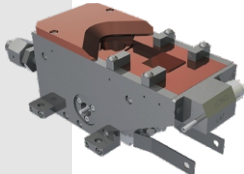

221/224

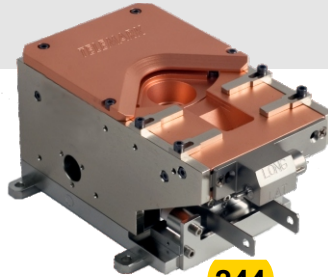

244

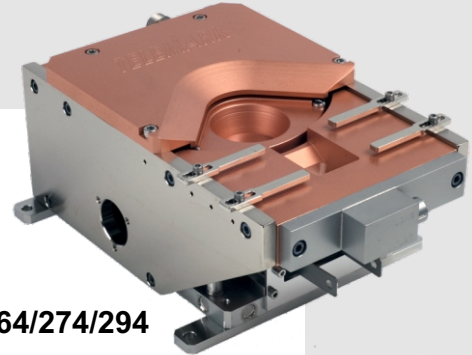

264/274/294

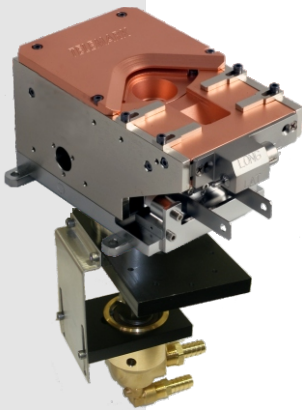

246

- **ROTATABLE HEARTH IS REMOVABLE FOR EASY CLEANING OR CHANGING OF CRUCIBLES**
- 270° beam deflection (Hidden Filament)
- Proprietary, patented water cooling design means longer crucible life and more consistent evaporation of material
- Rugged, reliable construction
- Designed for ease of use and maintainability
- Permanent magnet for primary beam positioning to provide improved control of evaporation process
- Durable emitter assembly with unique design for increased filament life and simple maintenance
- Plug-in emitter assembly for easy filament replacement
- Side or bottom crucible rotation drive
- Integral rotation feedthrough on models 246/266/276/296 eliminates water to vacuum seal

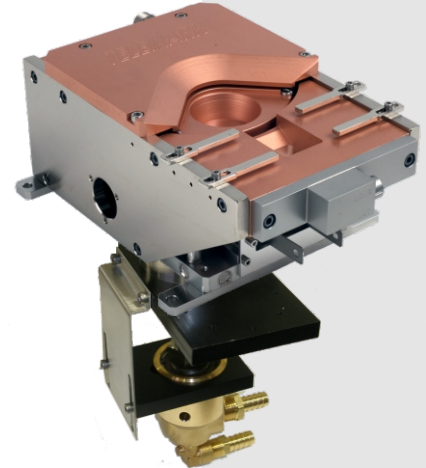

266/276/296

Model 295 Large Capacity, Multi-Pocket Source

For applications requiring large evaporation materials inventory (e.g. multiple or thick layers, extended throw distances) the **Model 295** Source provides a wide range of crucible sizes including 6x100cc, 16x15cc, 10x40cc, and a 1486cc trough. Available in 10Kw or 15Kw versions, with Arc-Suppression available as an option.

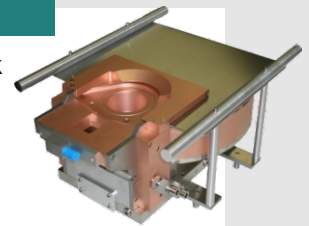

Model 263 "Crucible-less" Source

For customers wishing to supply the crucible as part of their mechanical assembly, the **Model 263** crucible-less source offers a compact, cost-effective solution. End users can expect long filament life from this versatile source, which can be supplied with optional arc-suppression.

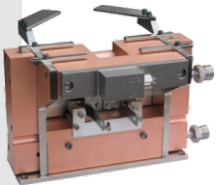

Near UHV Models 249/269/279

The addition of a magnetic fluid rotary feedthrough to our standard source bodies, for crucible rotation and water cooling, allows these sources to be pumped into the -10 Torr range.

Sources mounted on CF Flanges

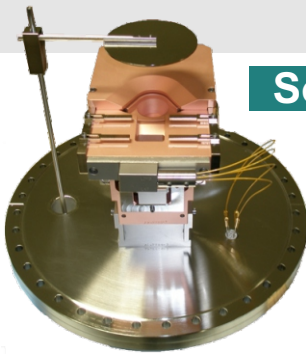

246 on 16" CFF

		Minimum Flange Size					
		211/218	272/259	221/224	244	264	274
Horizontal (Side Mount)		8" CFF	10" CFF	6" CFF	10" CFF	12" CFF	12" CFF
Vertical (Bottom Mount)		10" CFF	14" CFF	10" CFF	12" CFF	12" CFF	16.5" CFF
		246/249		266/269		276/279	
Vertical (Bottom Mount)		12" CFF	12" CFF	16.5" CFF			

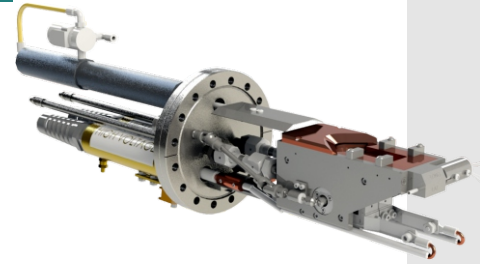

224 on 6" CFF

Rotatable Multi-Pocket Sources

Pockets	Size	221		224		244/246/249		264/266/269		274/276/279		294/296		295	
		Side	Bottom	Side	Bottom	Side	Bottom	Side	Bottom	Side	Bottom	Side	Bottom	Side	Bottom
4	2cc	-05	-06												
4	4cc			-63	-64	-63	-64								
4	7cc					-27	-28	-27	-28	-27	-28				
4	15cc							-01	-02	-01	-02				
4	25cc							-07	-08	-07	-08				
4	30cc							-19	-20	-19	-20	-19	-20		
4	40cc w/web									-61	-62				
4	40cc w/o web									-45	-46	-44	-45		
4	2x15cc/2x25									-37	-38				
6	4cc					-65	-66								
6	7cc					-05	-06	-05	-06	-05	-06				
6	15cc							-11	-12	-11	-12	-11	-12		
6	25cc									-17	-18	-17	-18		
6	30cc											-75	-76		
6	40cc											-69	-70		
6	100cc (10kW*)													-51	-52
6	100cc (15kW*)													-01	-02
6	2x7cc/4x15cc							-29	-30						
6	4x4cc/2x15cc							-09	-10						
8	7cc							-13	-14	-13	-14				
8	15cc											-01	-02		
8	25cc											-07	-08		
10	40cc(10kW*)													-71	-72
16	25cc (10kW)													-73	-74
20	15cc (10kW)													-21	-22
Trough	190cc							-15	-16						
Trough	275cc									-31	-32				
Trough	440cc											-79	-80		
Trough	1486cc (10kW*)													-91	-92

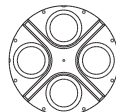

4 Pocket



6 Pocket



Banana Pocket

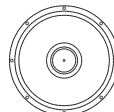

Trough

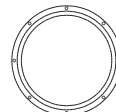

Pan

Specifications

	221/224	211/218/244/246	264/266/269/273** 274/272**/259	294/296	295
E-Beam Deflection	270°	270°	270°	270°	270°
Power Rating	3 kW(221), 4 kW(224)*	6 kW*	10 kW*	12 kW	10 kW* / 15 kW*
High Voltage Range	-5 kV to -7 kV	-6 kV to -10 kV	-6 kV to -10 kV	-6 kV to -10 kV	-6 kV to -10 kV
Lateral Coil Resistance	8.5 ohms (224)	8.5 ohms	3.0 ohms	3.0 ohms	3.0 ohms
Long. Coil Resistance	7.5 ohms (224)	7.5 ohms	9.6 ohms	9.6 ohms	9.6 ohms
Water Requirements	2 gpm(min.)@ 60°F	2 gpm(min.)@ 60°F	3 gpm(min.)@ 60°F	5 gpm(min.)@ 60°F	5 gpm(min.)@ 60°F

*Nominal value; actual power rating may vary, depending on customer's process.

** Model 273's power rating is 6 kW, Model 272's power rating is 14 kW

Single Pocket Sources

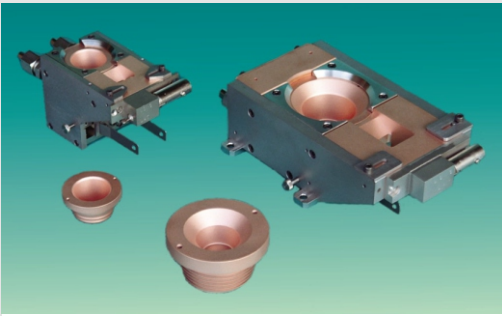

Pocket Size	Standard Sources		UHV Sources	
	Model 211	Model 259/272	Model 218	Model 259
1.5cc	211-05		218-05	
4cc	211-04		218-04	
7cc	211-07	272-01	218-07	259-01
15cc	211-15	272-02	218-15	259-02
25cc		272-03		259-03
30cc		272-30		259-30
40cc		272-04		259-04
100cc		272-05		259-05
160cc		259-50		259-60

Model 211 and UHV Model 218

High Performance in a Small Package with Crucible Volumes up to 15cc.

- Rated at 6kW* of power when operated at voltages from -6 to -10kV.
- Compact design for use in small research and development systems or wherever space is an important consideration.
- The model 218 UHV uses the same basic components as the standard model 211, with non-interchangeable crucibles and all metal sealing.
- Coils sealed in stainless steel cans are standard.

Model 257/272 and UHV Model 259

Large Capacity Source

Performance Proven in High-Power Production Applications

- Available in crucible volumes up to 160cc for long, uninterrupted evaporation.
- Rated at 14kW* when operated at -10kV.
- Capable of evaporating high rates of material such as aluminum. This makes these sources ideal for processes that require a coating layer of one micron or more.
- These sources are also well suited for operation at lower power levels where a large capacity of subliming materials might be required.

* Nominal value; actual power rating may vary, depending on customer's process.



Feedthroughs

Telemark offers a broad range of standard and custom magnetic fluid feedthroughs. Also offered are high voltage, dual water, rotary and octal instrument feedthroughs in the one inch and 32mm o-ring sealed bolt type, and in the 2 3/4" CF metal seal type. Water flow switches are also available and recommended.

Crucible Indexers

The Model 379 indexer provides either manual or PLC selection of four or six pockets, and continuous or retrograde (banana pocket) operation with speed control. The Model 395 offers 8, 10, or 12 pocket selection, plus continuous or retrograde motion.



Shutters

Electro-Pneumatic shutter controls are available with 1", 32mm, or 2-3/4" CFF feedthrough shutter assemblies.

Arc-Suppression Option®

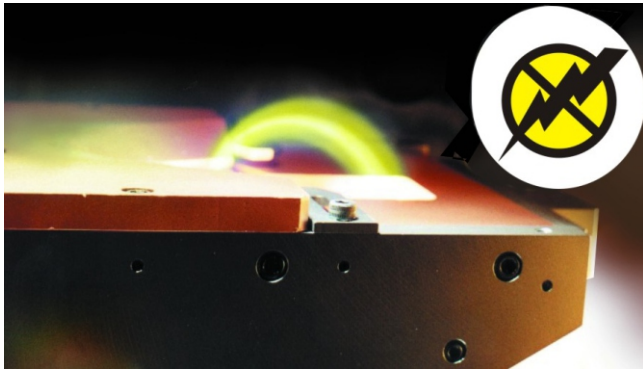

FEATURES:

- Operates in hostile particulate laden environments
- Does not react to ion sources or other discharges
- Operated at pressures $> 5 \times 10^{-3}$
- Available in a wide range of crucible sizes to 6 X 100cc

Source with Arc-Suppression Running @ >5 millitorr in O_2

A source with the Arc-Suppression option is ideal for many applications, such as for optical coating and for ion plating without a pressure barrier. The reduction in arcing results in improved film quality, improved yields, and fewer arc-related maintenance issues.

Arc-Suppression is available as an optional feature for most Telemark production sources. It has a footprint similar to standard sources, but with the high voltage feedthroughs incorporated into the source. Two separate cooling water lines are required to cool the source body and the high voltage assembly.

Typical Configurations (Others Available)

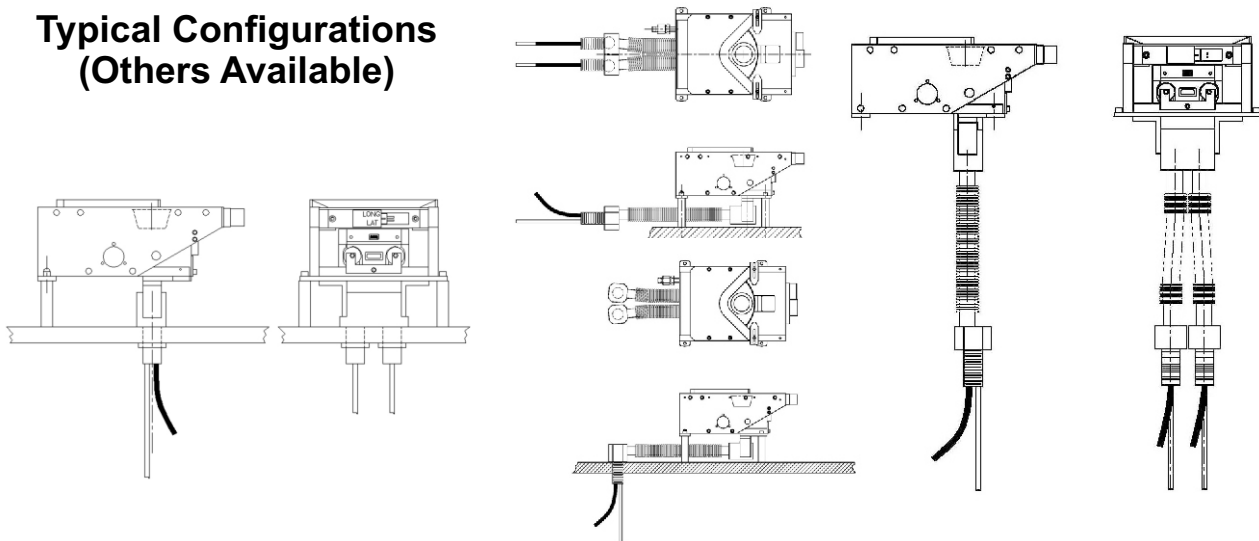

© U.S. Patents PE35,024 and 6,064,686, plus foreign counter-parts

Self-Sealing Cover Plate

An optional self-sealing cover plate is available for applications where cross-contamination between materials is a concern. The front of the cover plate moves up as the crucible indexes to the next pocket. It is actuated by bearings attached to the crucible and is pivoted at the rear of the assembly. When the cover plate is in the closed position, it is in contact with the crucible, thus preventing any migration of the material being evaporated to adjacent pockets. The cover plate is water cooled and the forward edge is angled to avoid evaporant accumulation.

